

XII Воронежский Промышленный Форум



3DEXPERIENCE®

SolidWorks

Александр Щипанов
Менеджер по развитию бизнеса
SolidWorks в России

SOLIDWORKS Mission

В Д О Х Н О В Л Я Т Ь
И Н Н О В А Ц И И

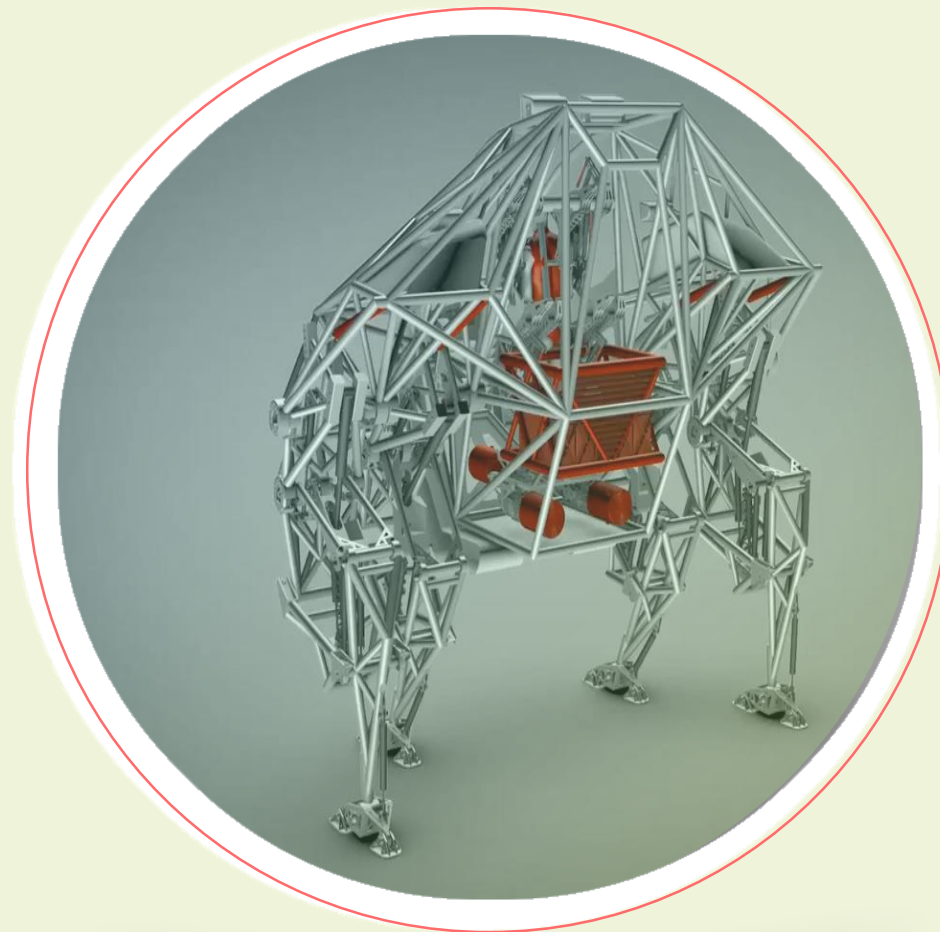

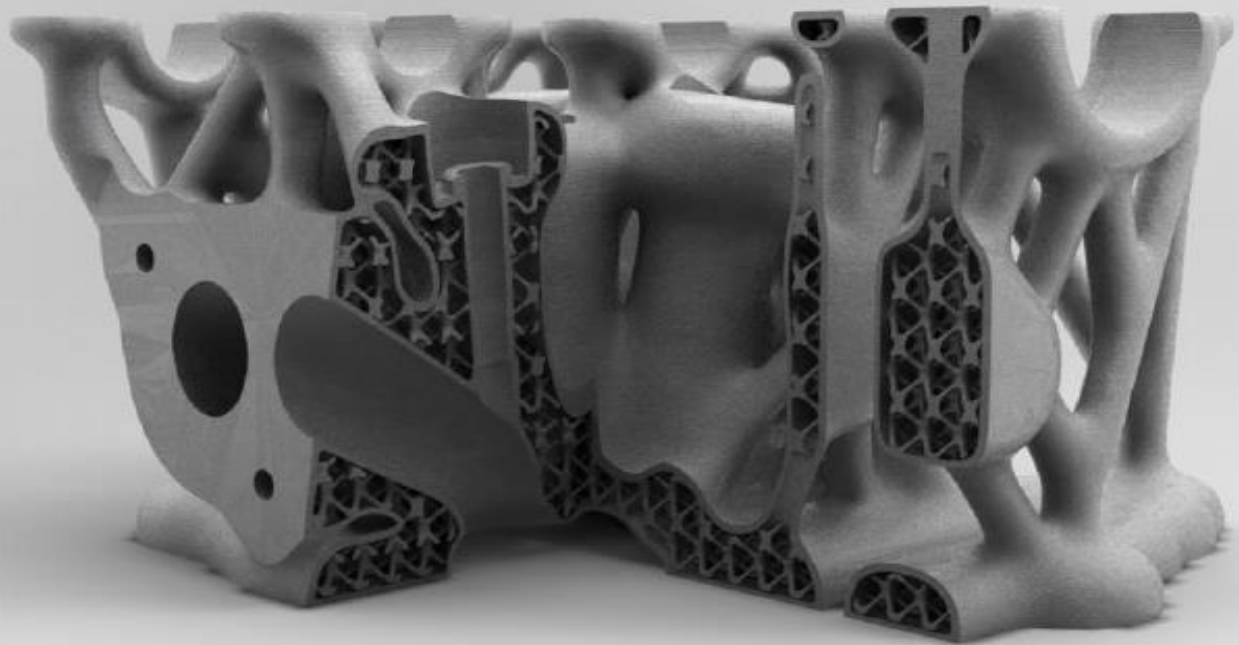
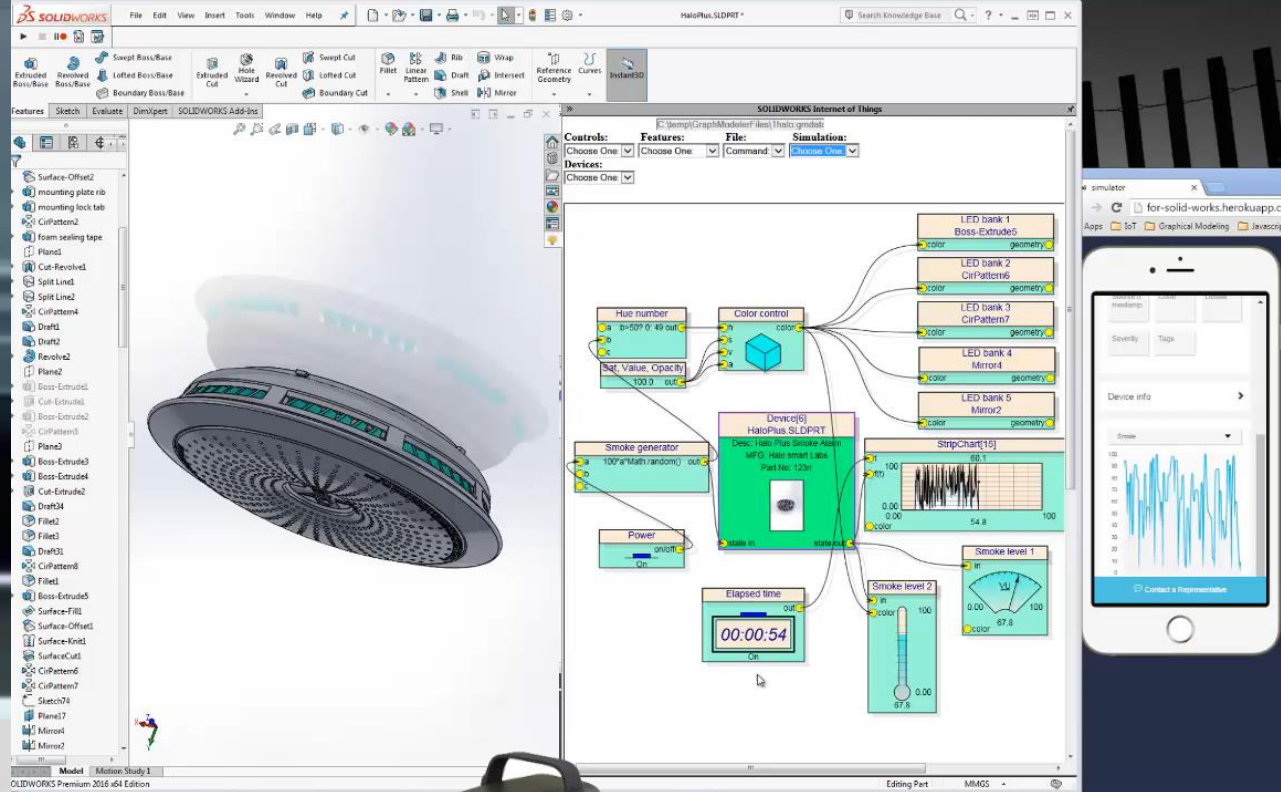

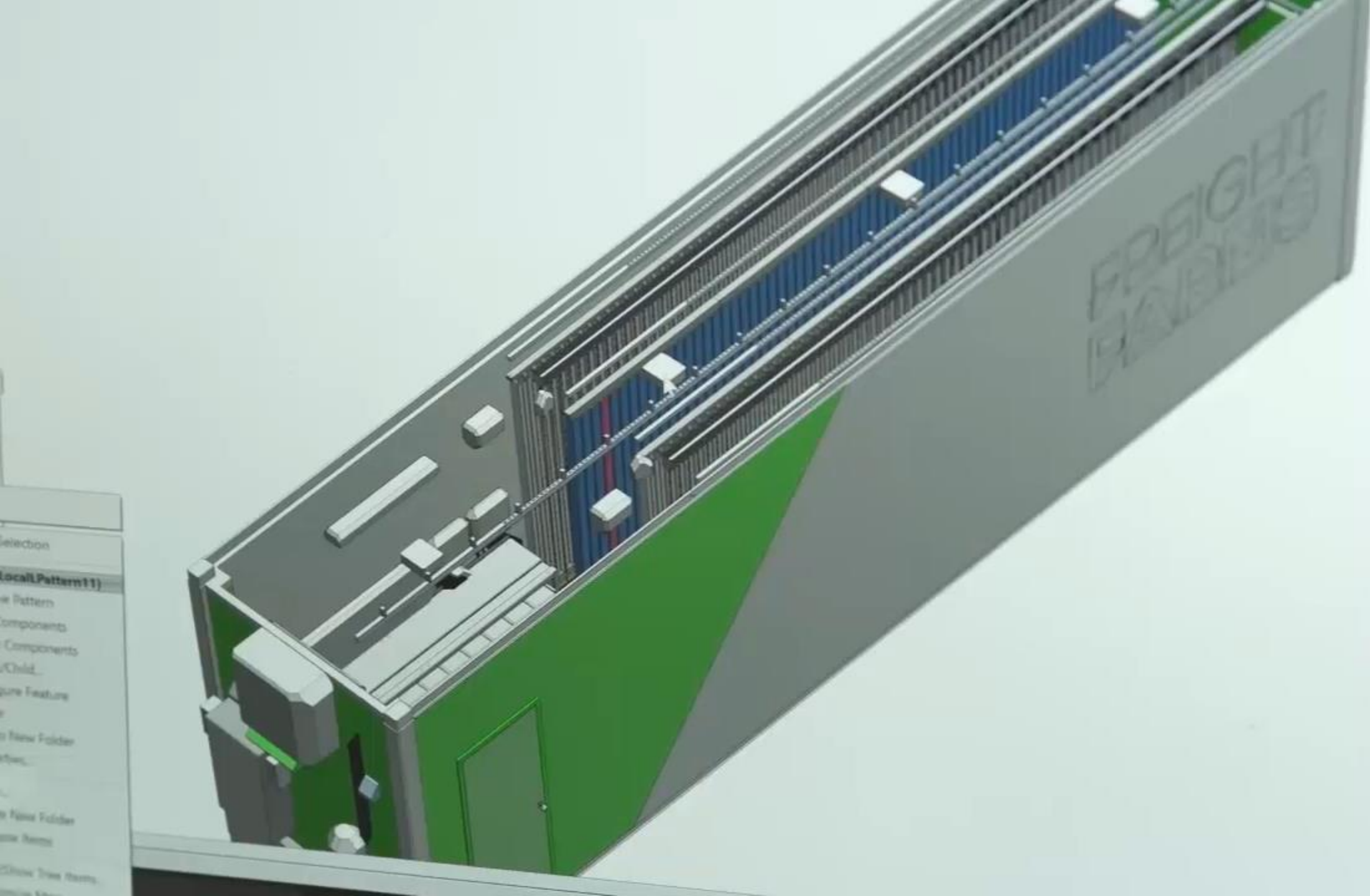

- Selection
- (LocalPattern1)
- Pattern
- Components
- Components
- Child...
- Feature
- New Folder
- ...
- New Folder
- ...
- Show Tree Items

SUPERSONIC FLIGHT

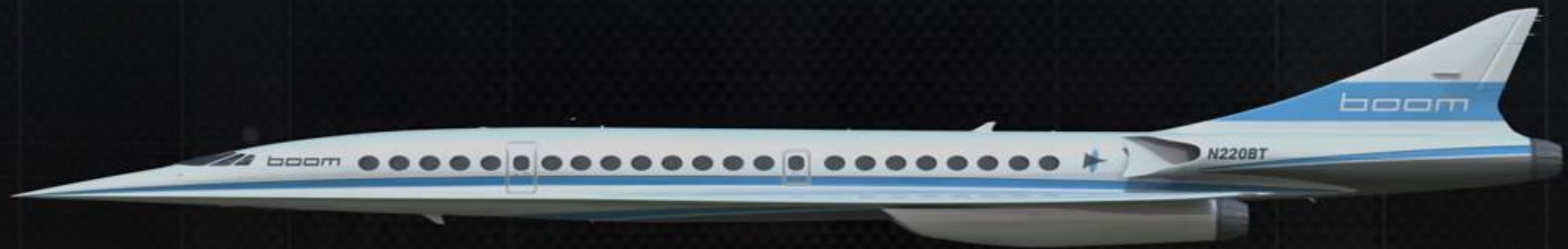

Corporate profile

- Startup project
- >10 years of experience
- Smart trash as a part of Smart City concept

Technical highlights

- Designed in SolidWorks Professional
- Features used: Motion (for assembly manual), PhotoView 360 (presentation), Toolbox library
- Plan to extend functions with: Routing, Plastics, Simulation

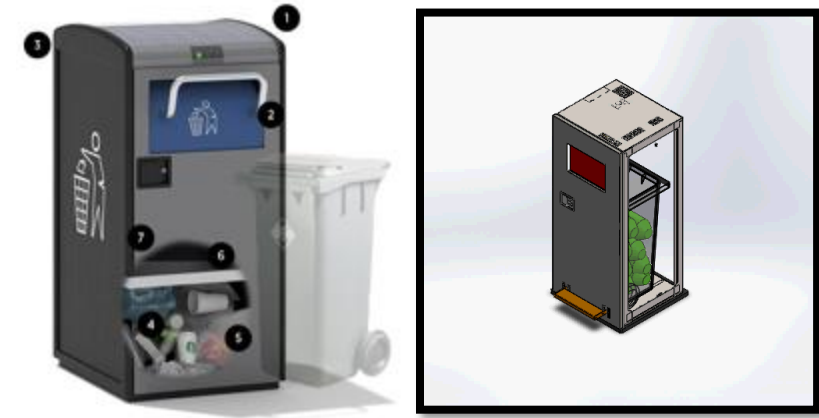

Corporate profile

- High-Tech company
- Form 2015
- Headquarter in Moscow + 3 foreign reps: Ukraine, UAE, Spain
- Main product – Promotion robot KIKI

Technical highlights

- Designed in SolidWorks Professional
- Top-Down design methodology
- Big assembly
- Complicated surface modeling



Corporate profile

- Biggest research university in Russia
- Founded in 1899
- Blood vessel designing using SolidWorks

Technical highlights

- Designed in SolidWorks Premium
- Features used: Simulation flow, Plastics
- Innovative area of usage

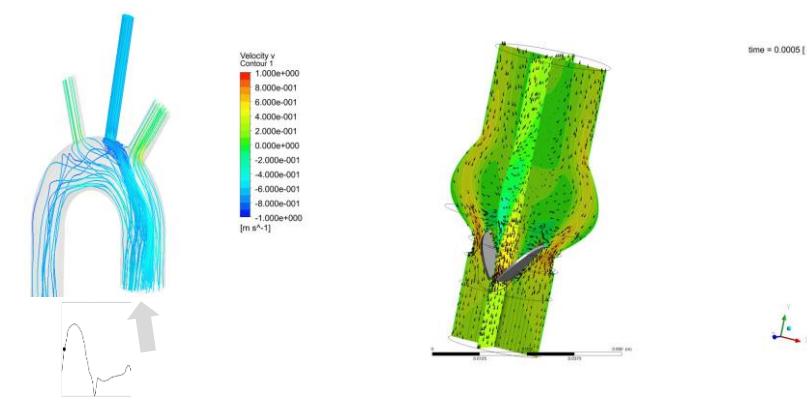

Промышленное оборудование



- Станок
- Промышленные роботы
- Промышленные 3D принтеры
- Automated Guided Vehicle

Станки, Промышленные роботы & 3D Принтеры



- Специализированное автоматизированное промышленное оборудование
- Engineering Services and Line Builders
- Конвейеры
- Oil and Gas field machinery

Специализированное технологическое оборудование



- Сельхоз техника
- Промышленный погрузчик
- Строительная & Горнодобывающая техника
- Мостовые краны, подъемники и монорельсовые системы

Большегрузная техника & Оборудование



- Лифты
- Эскалаторы
- Проходные
- Системы отопления, вентиляционные и кондиционирования

Оборудование для строительства



- Моторы и генераторы
- Гидравлическое оборудование
- Подшипниковое и сцепные компоненты
- Отопление и охлаждение (не системы кондиционирования)
- Резаки, пресс-формы и штампы
- Промышленная электроника

Силовое гидравлическое оборудование



- Металлические компоненты
- Элементы из листового металла
- Пластиковые элементы
- Insulation and Sealing Products

Металлические и пластиковые компоненты



- Производство покрышек
- Мастерские по ремонту покрышек

Изготовление покрышек

Широкая экосистема

5,900,000 Users

280,000 Companies

33,500 Academic
Institutions

600 Fab Labs

170 Incubators &
accelerators

300,000 Certified users

1,350,000 MySolidWorks
members

1,750,000 3DCC members

1,760,000 Facebook fans

750 Software & hardware
partners

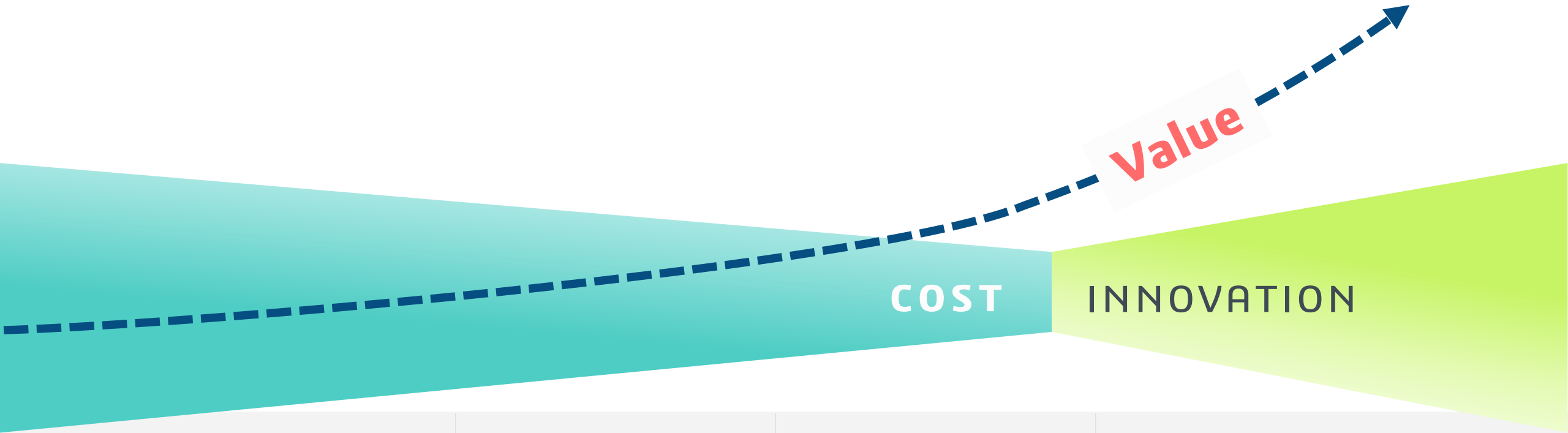

1784



1870



1969



2018



Технологический Ренессанс



Action

The 3DEXPERIENCE Platform

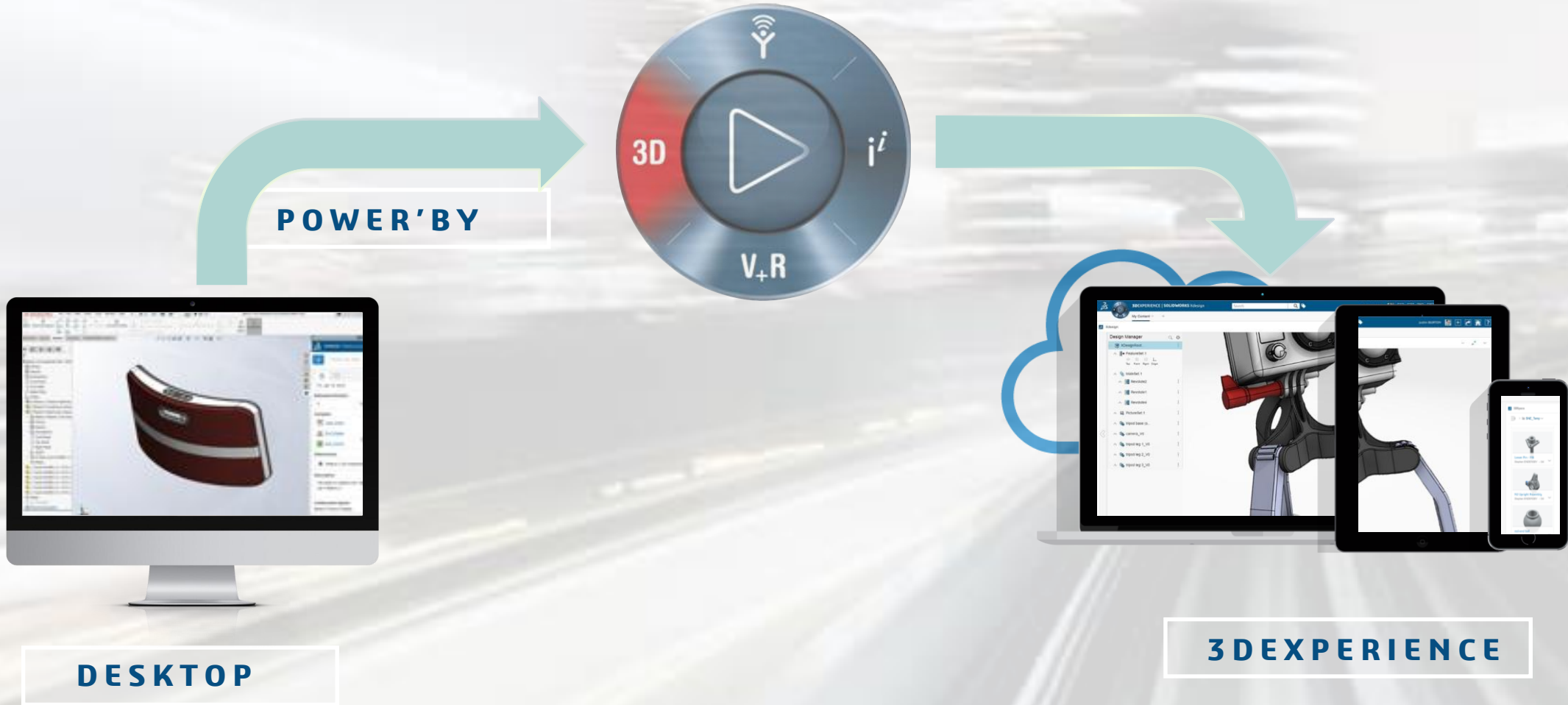

DESKTOP

3DEXPERIENCE

Action

The classic Design Experience



DESKTOP

SOLIDWORKS Roadmap.

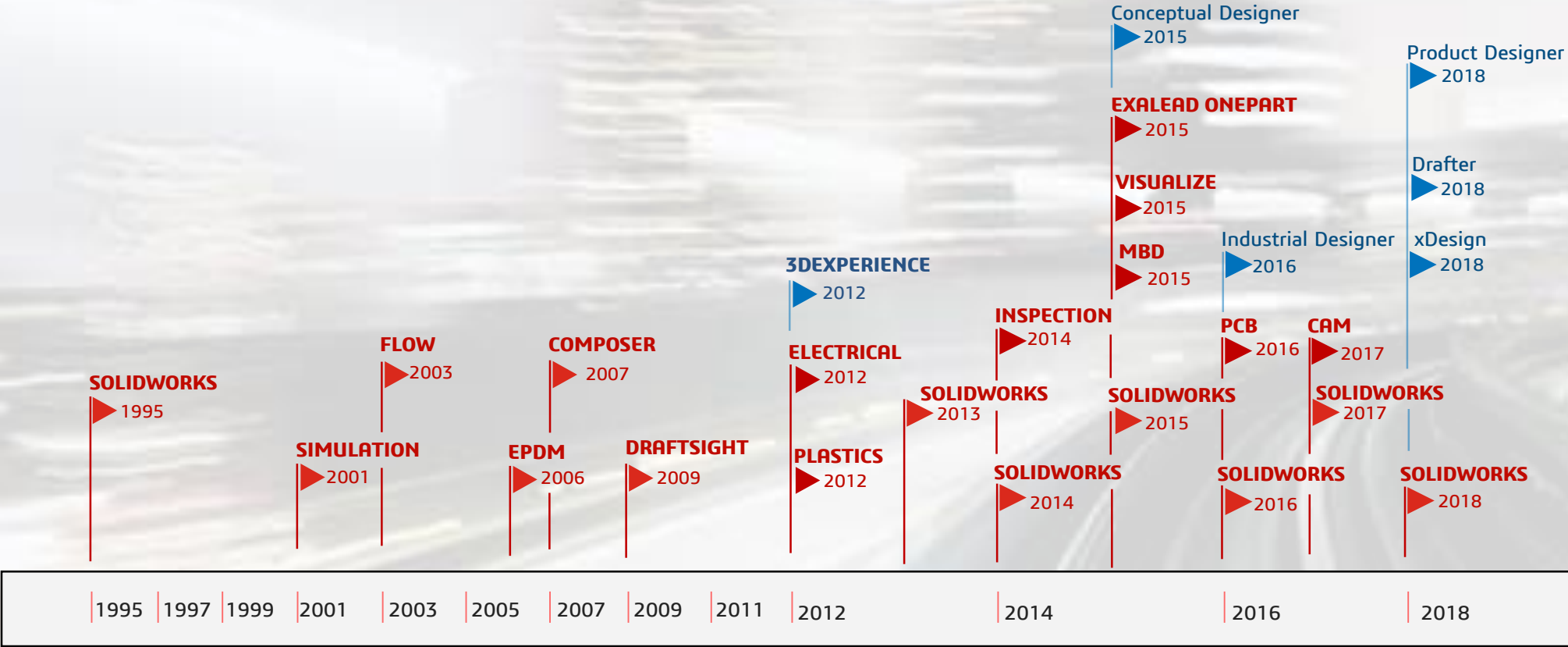

SOLIDWORKS 2019

Иновации

Exciting new ways to work with SOLIDWORKS

Complete Design to Manufacture Solution

Экосистема

Производительность

Tackle your biggest design challenges

Capture critical design detail with ease

Детали

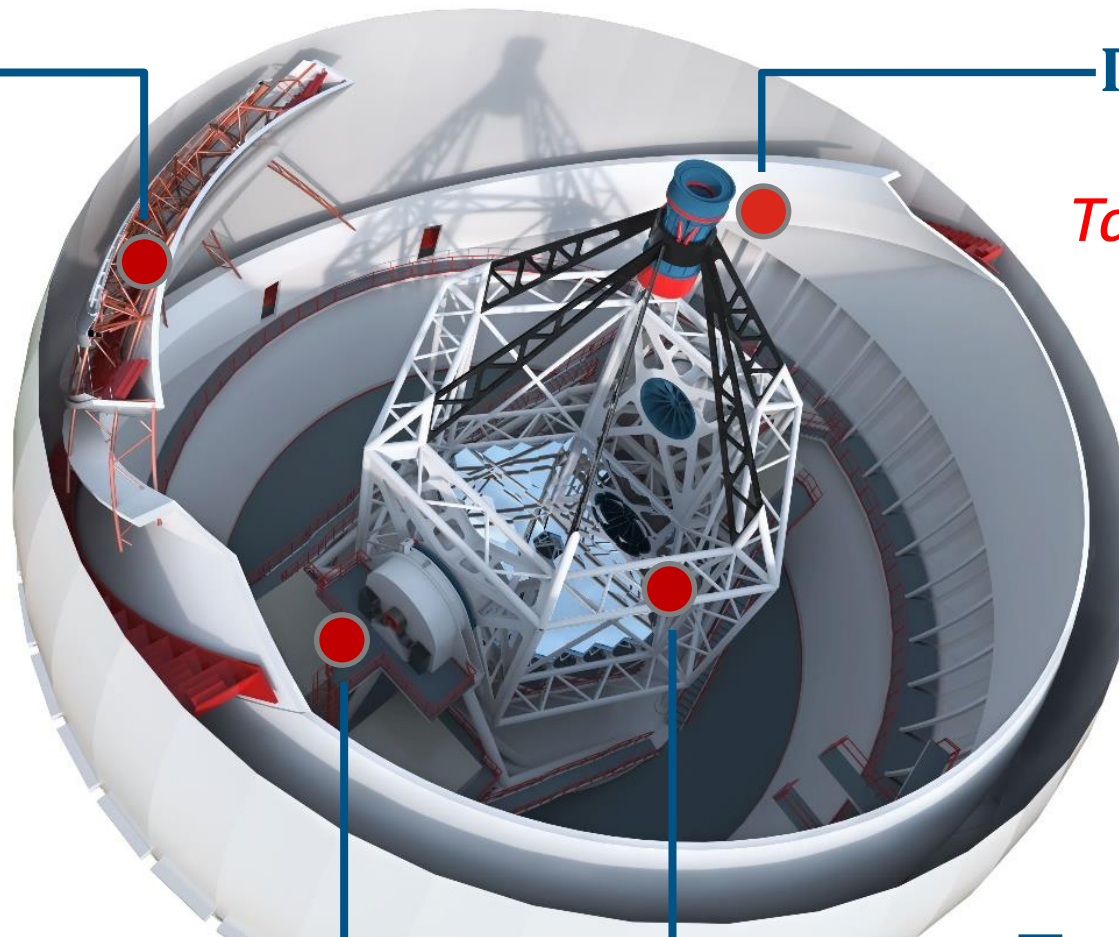

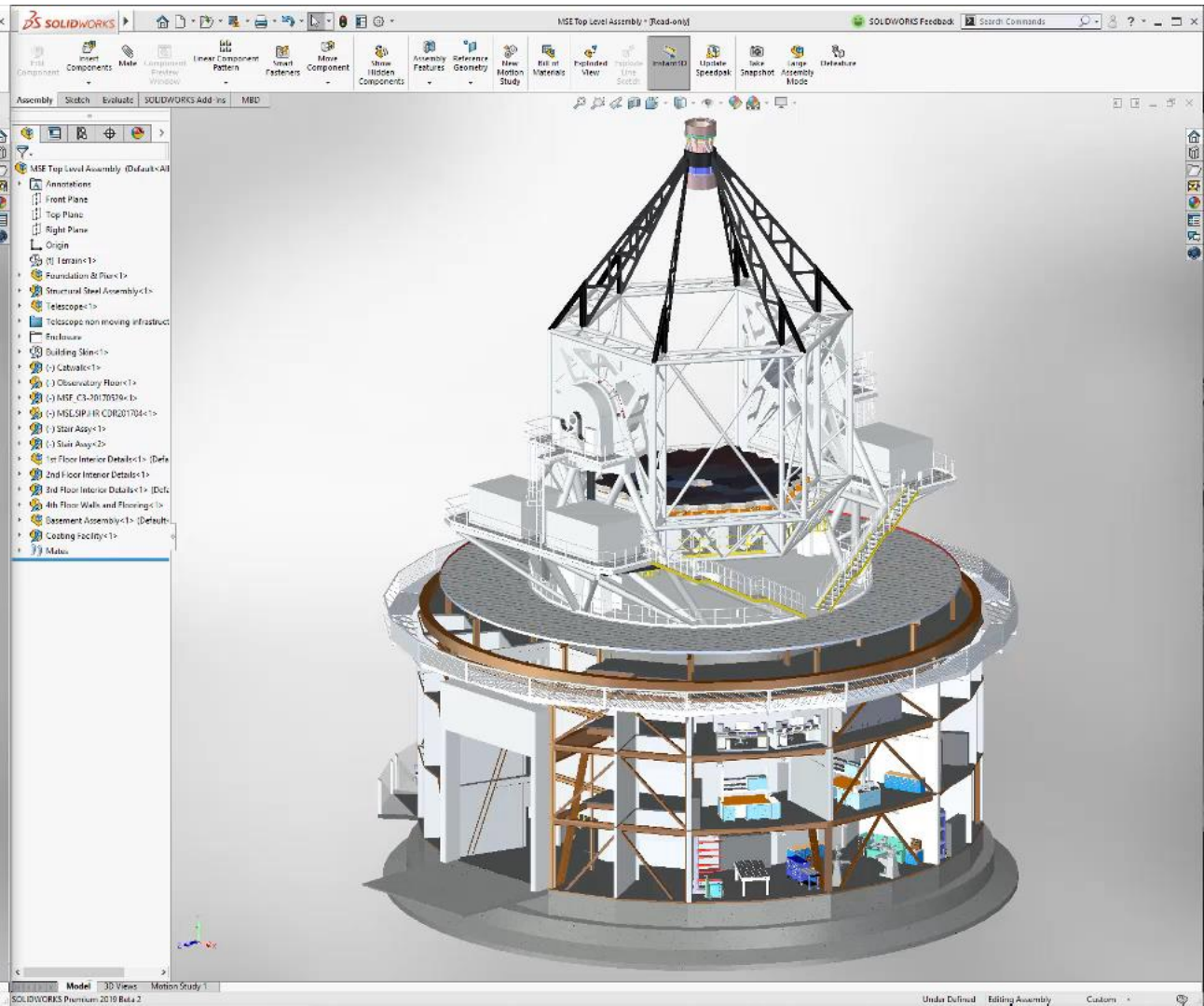
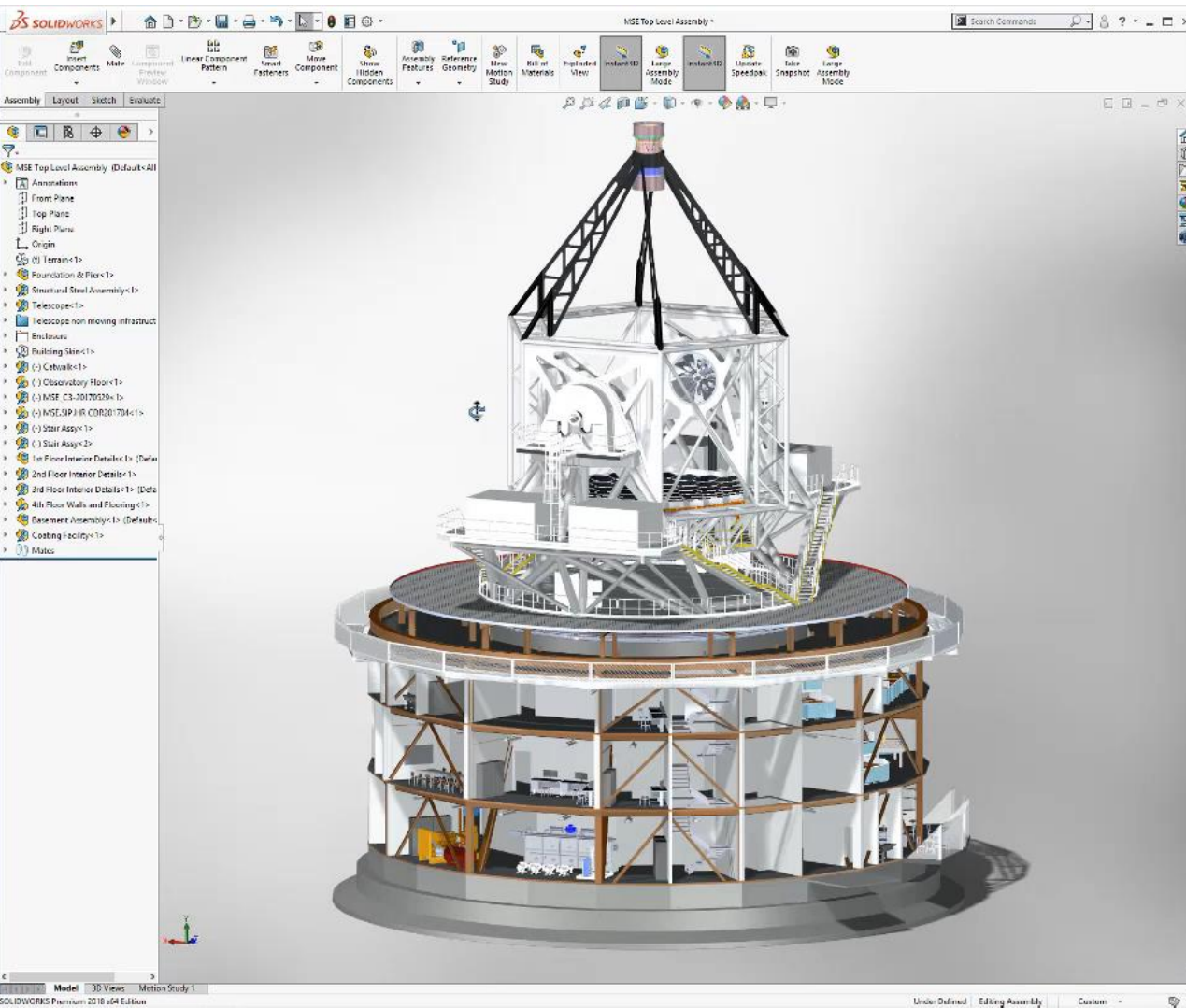

Интегрированная Мехатроника



ELECTRICAL

Интегрированный дизайн в производство

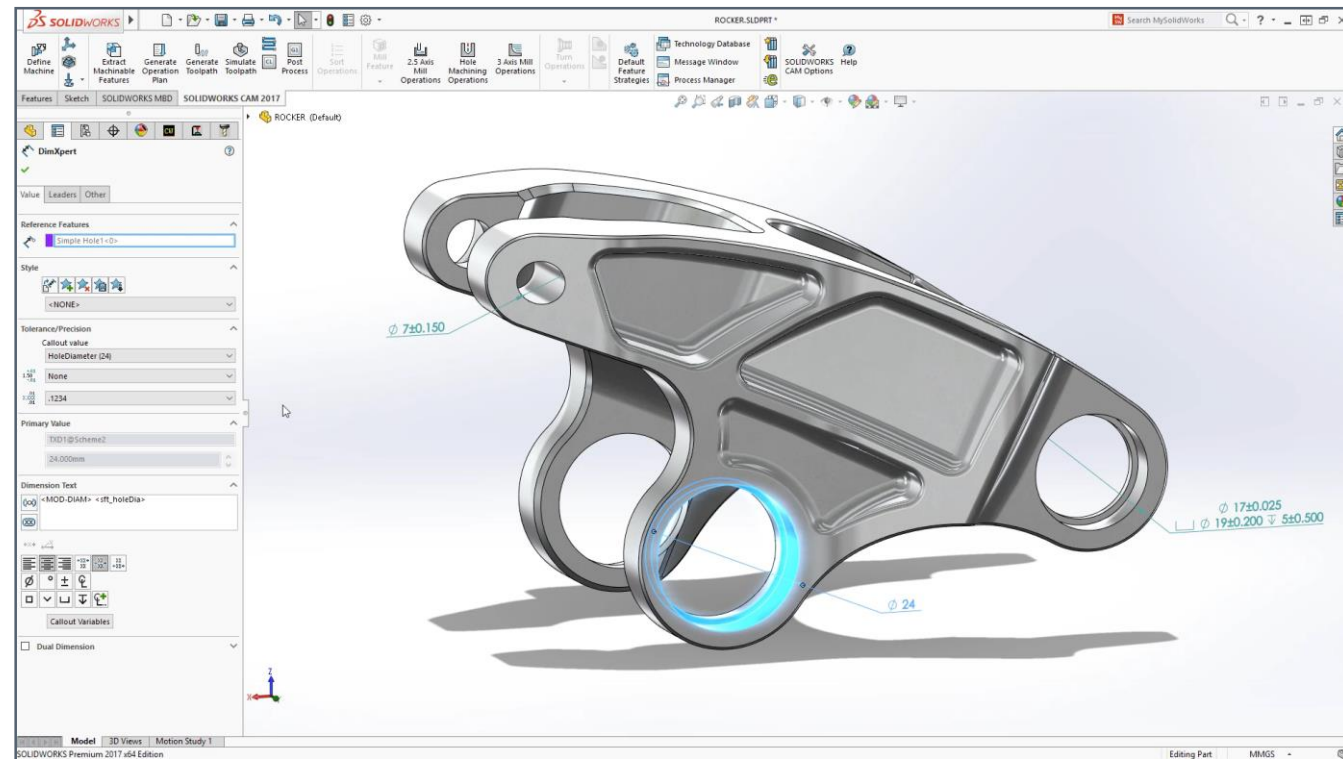

C A M

Гибридное моделирование

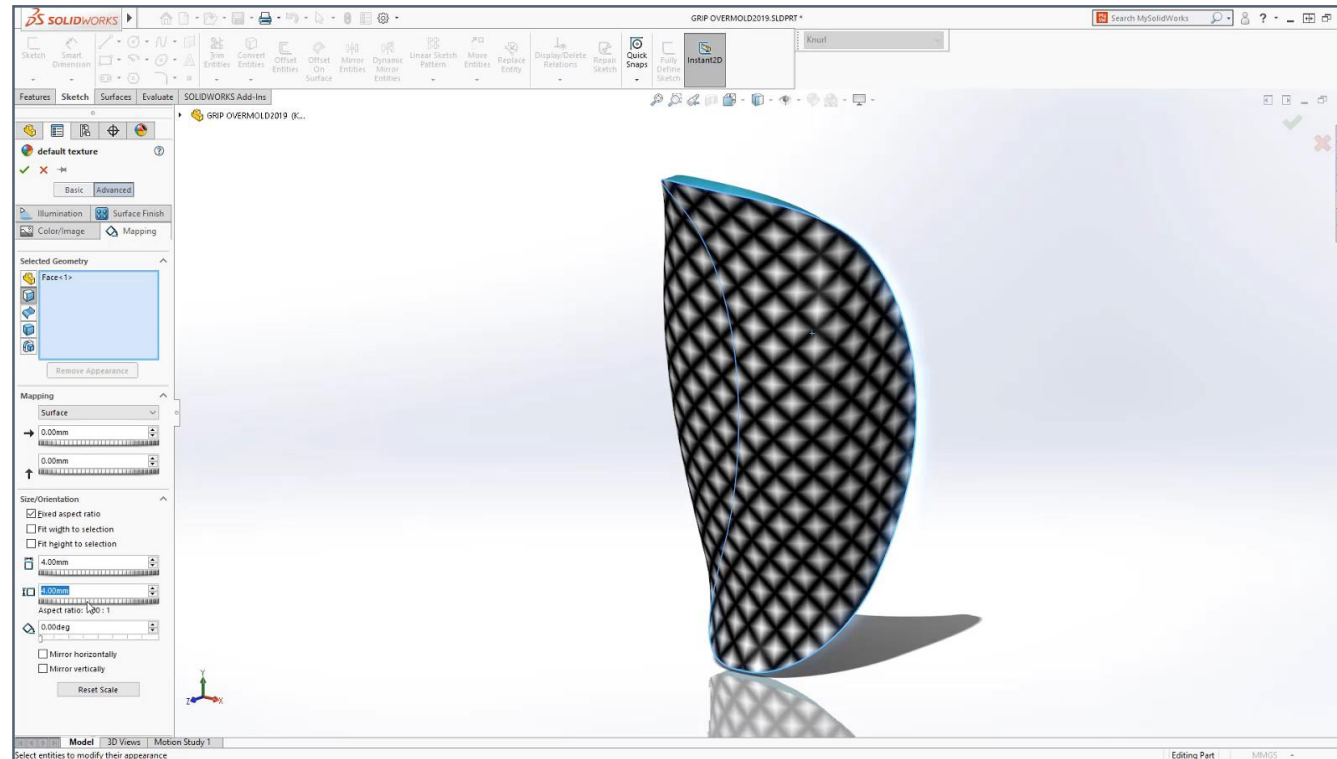

MESH

Design for 3D printing.

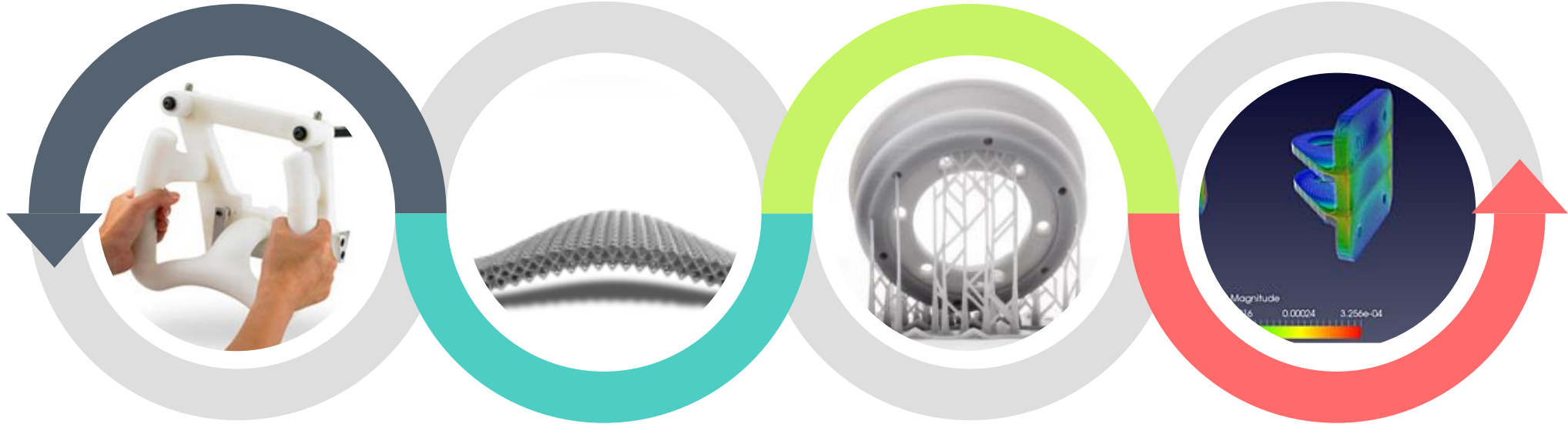

Fast Prototyping.

Create prototypes cheaper and faster for form and fit.

Lattice.

Create organic and lightweight parts for new applications.

Support Structures.

Automate the trial & error process, gain speed and enable metal parts.

Print Validation.

Predict structural strength and fidelity of 3D printed parts.

AR & VR Experiences.

| USERS |

Direct VR

Enable connection of SolidWorks Desktop to devices such as HTC Vive and Oculus Rift for design reviews.

| USERS OF USERS |

Publish AR/VR

Export **gLTF** — portable, open file format for AR/VR/Web — from SolidWorks for users to publish their designs into downstream AR, VR & Web experiences.



Action

The Complete Design Experience

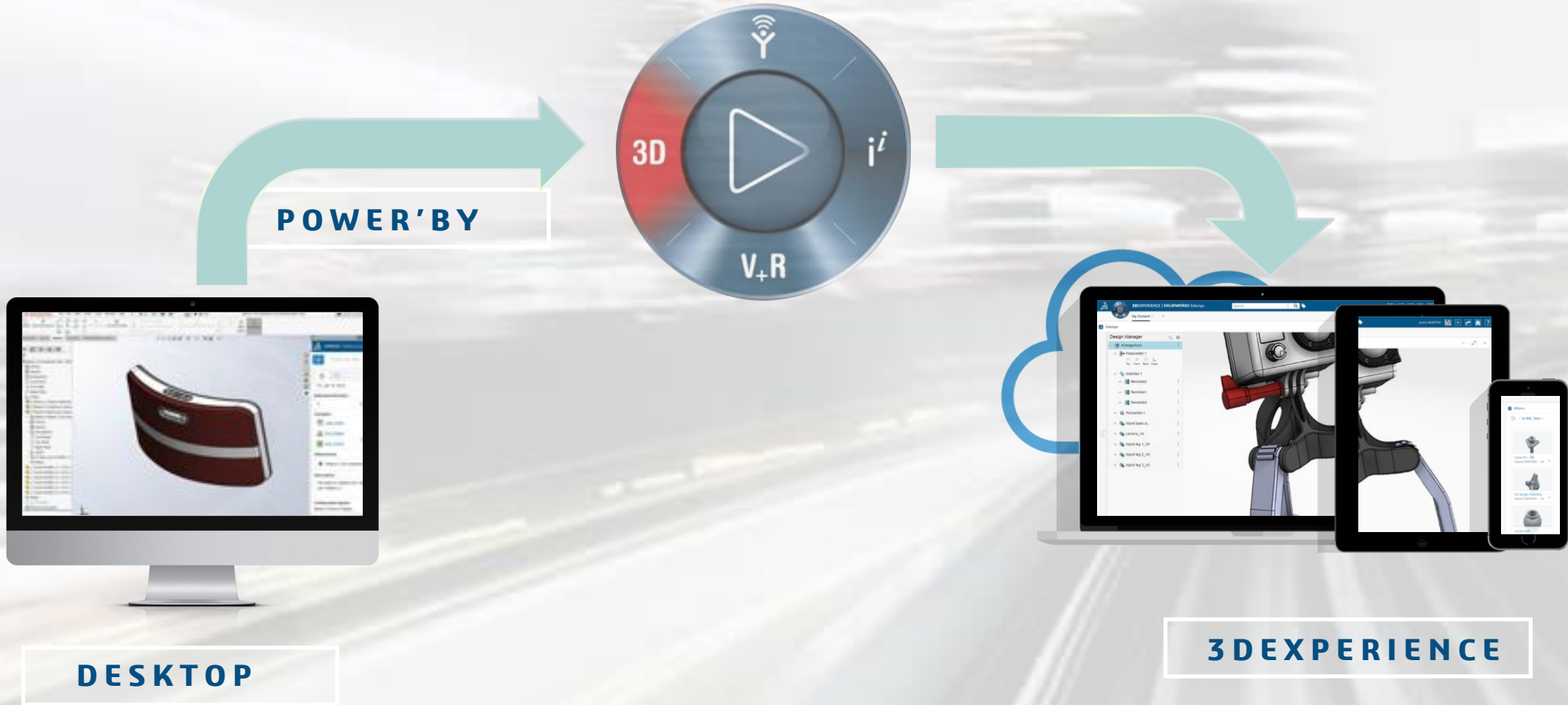

Продвинутое моделирование

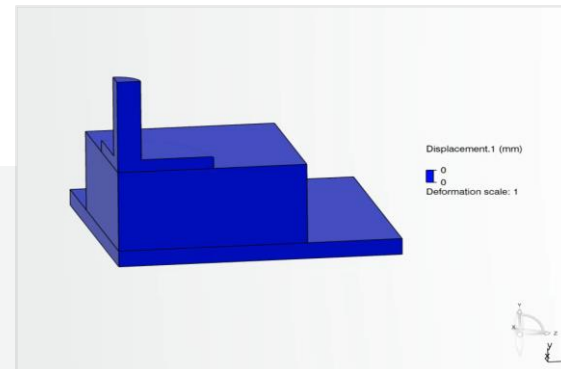
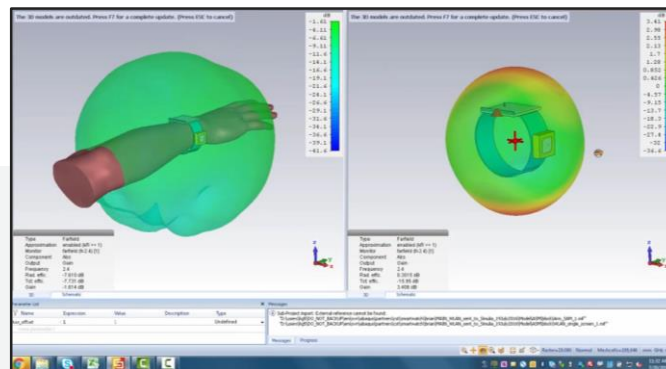
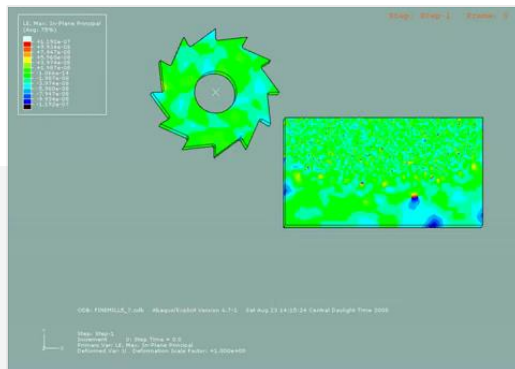
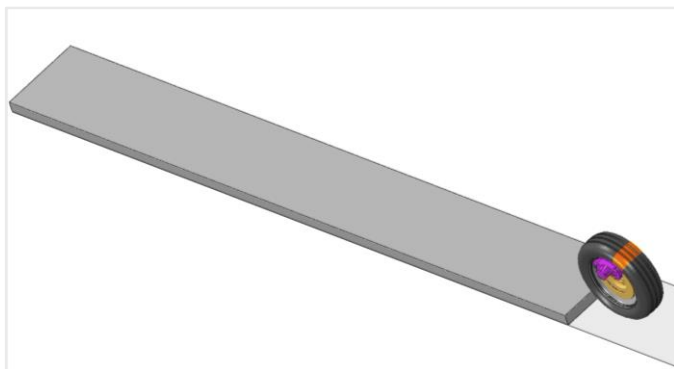

INDUSTRY

INDUSTRY

INDUSTRY

INDUSTRY

 **3DEXPERIENCE** | **PLM**

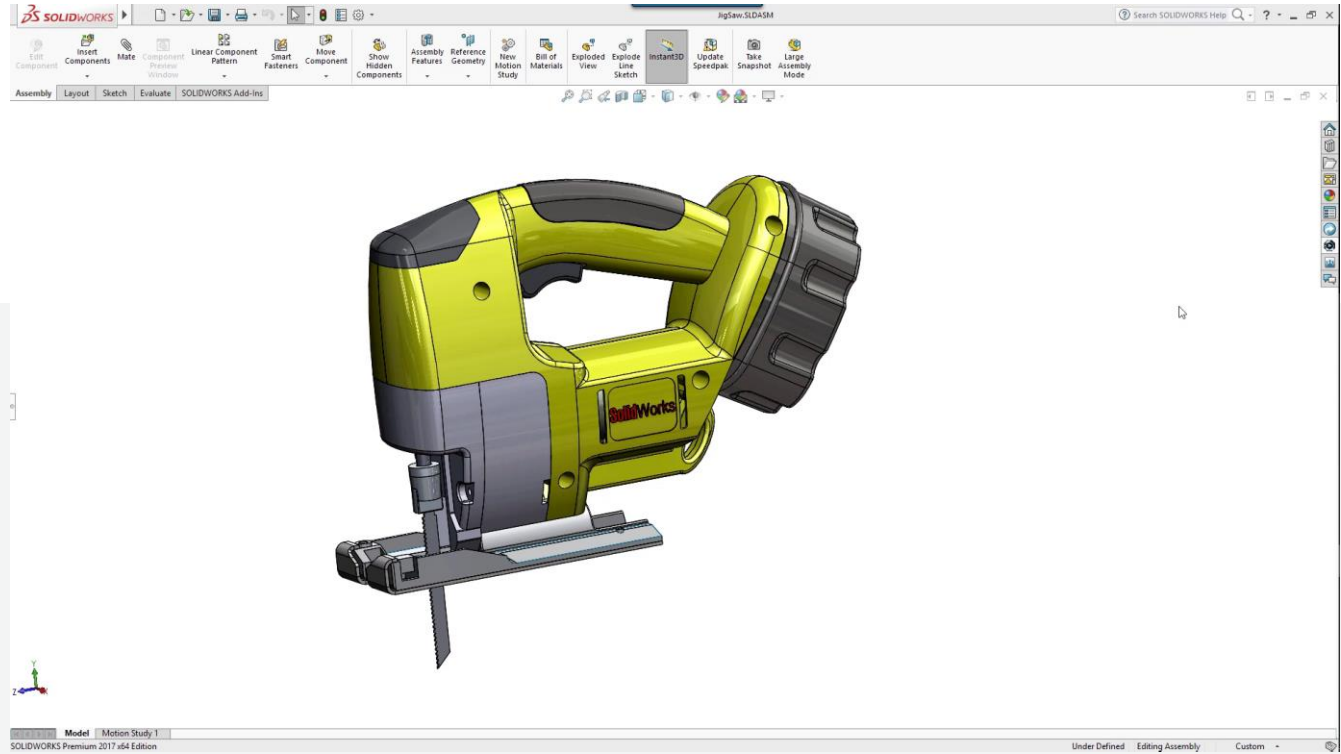

SOLIDWORKS | PLM SERVICES



POWER' BY

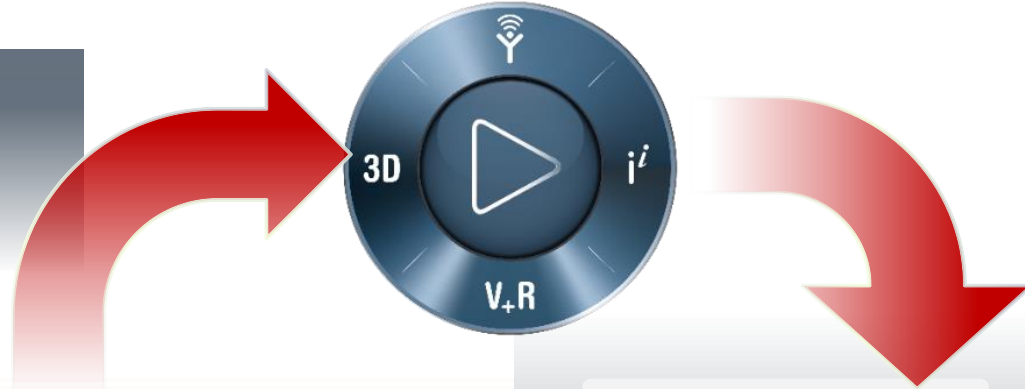

DESKTOP



3DEXPERIENCE



THANK YOU.

